

CERTIFIED SOLUTIONS  
FOR THE RAILWAY SECTOR



## GRATINGS AND OTHER GRP-PRODUCTS FOR YOUR APPLICATION:

- + Barriers
- + Track crossings
- + Internal and external cleaning plants
- + Bridge Floorings
- + GRP-Railings / Pluggable Railings
- + Platforms / Constructions
- + Access Platforms
- + Construction and railing profiles
- + Concrete trough coverings
- + Escape and emergency routes

### LICHTGITTER IN THE RAILWAY SECTOR

### SOLUTION-ORIENTED, RELIABLE, COMPETENT

THE RAIL SECTOR HAS SPECIAL REQUIREMENTS FOR THE PRODUCTS AND THE SUPPLIERS. PRODUCTS MADE OF GLASS FIBER REINFORCED PLASTIC ARE BECOMING MORE IMPORTANT, BECAUSE THEY ARE WEATHER AND CORROSION-RESISTANT AS WELL AS NON-CONDUCTIVE AND SERRATED.

AS A FULL-SERVICE PROVIDER IN THE FIELD OF INDUSTRIAL FLOOR COVERINGS LICHTGITTER OFFERS A QUICK AND EFFICIENT SOLUTION FOR EVERY APPLICATION WHETHER MADE OF GRP, STEEL, STAINLESS STEEL OR ALUMINUM.

True to the motto, „Everything from one source“, we can offer you all the floor coverings you need for your projects in the railway sector, e. g. for track crossings, concrete trough covers, and escape routes made of gratings or perforated metal planks as well as complete systems made from GRP platforms including the substructure. As a long-standing partner of „Deutsche Bahn“, a wide variety of projects have already been implemented in the rail sector.

Lichtgitter GFK was one of the first companies to obtain the approval of the German Federal Railway Authority (EBA) as well as the manufacturer-specific product qualification (HPQ) for GRP gratings. Your advantages are not only in the complete range of industrial floor coverings, but also our product-accompanying services such as planning support and the preparation of installation plans.

## PRODUCT VARIETY OF LICHTGITTER:

### EVERYTHING FROM ONE SOURCE.

#### GRP

Glass fiber reinforced plastic (GRP) as a composite material plays an increasingly important role in Deutsche Bahn's civil engineering. The advantages of GRP are not only their low weight, but above all their high chemical resistance and non-conductive material properties. In addition to GRP gratings in various mesh spacings and surfaces, GRP structures, railings and ladders are also part of the product range of the Lichtgitter Group.

Lichtgitter GFK was one of the first companies to obtain the approval of the German Federal Railway Authority (EBA) as well as the manufacturer-specific product qualification (HPQ) for GRP gratings.

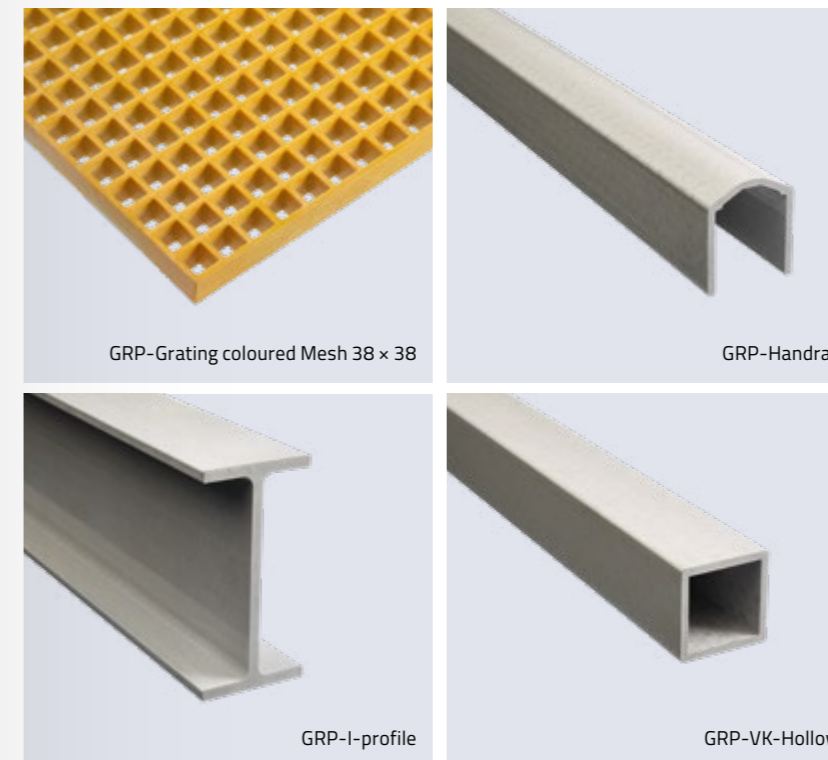
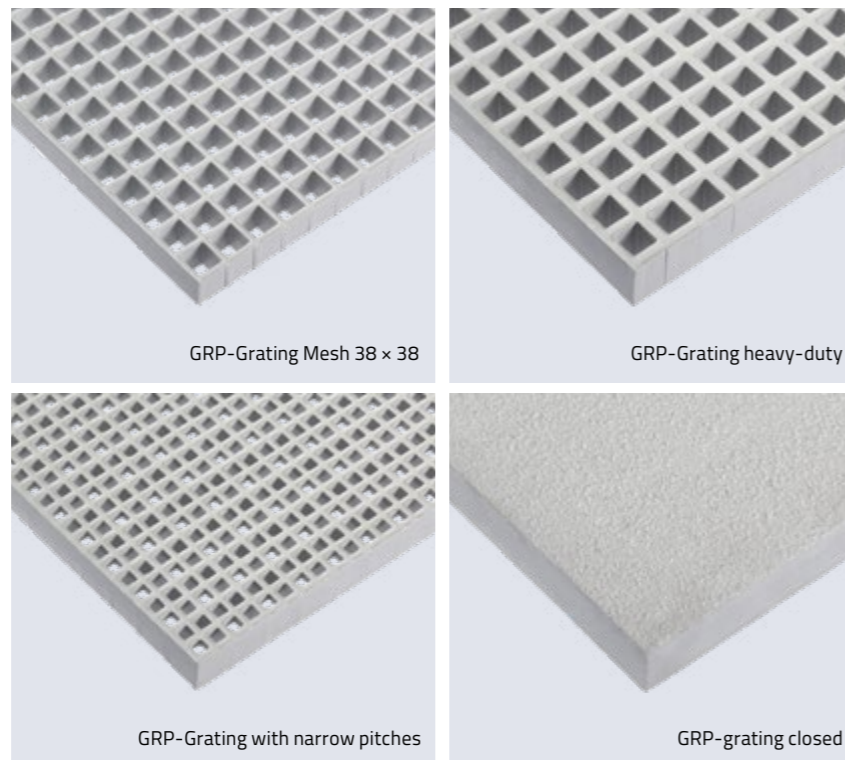

- + non-conductive material / does not need to be earthed
- + weather-resistant
- + corrosion-resistant
- + simple processing and assembly on the construction site
- + high slip resistance
- + high level of running comfort
- + long lifetime
- + low weight
- + German Federal Railway Authority approved
- + HPQ certified



#### STEEL

Gratings and perforated metal planks are used as easy-to-install load-bearing elements, e.g. for walkable and passable floorings, walkways, stairs and platforms. Due to many options in the choice of bearing bars, the selection of mesh spacing and the material in gratings and the different surface profiling of perforated metal planks, there are an infinite number of designs that meet many requirements in the railway sector.

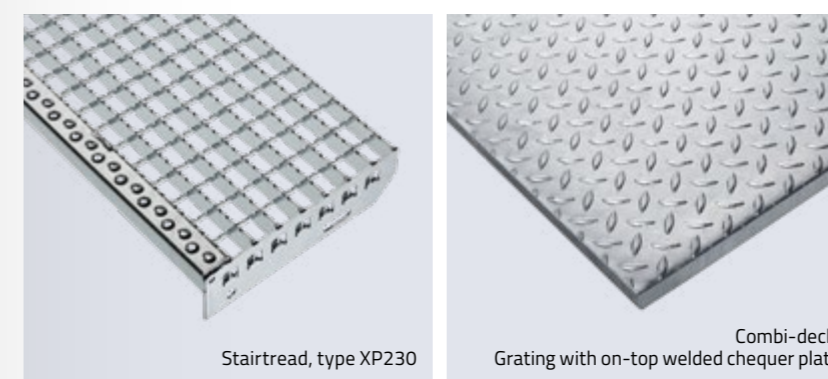
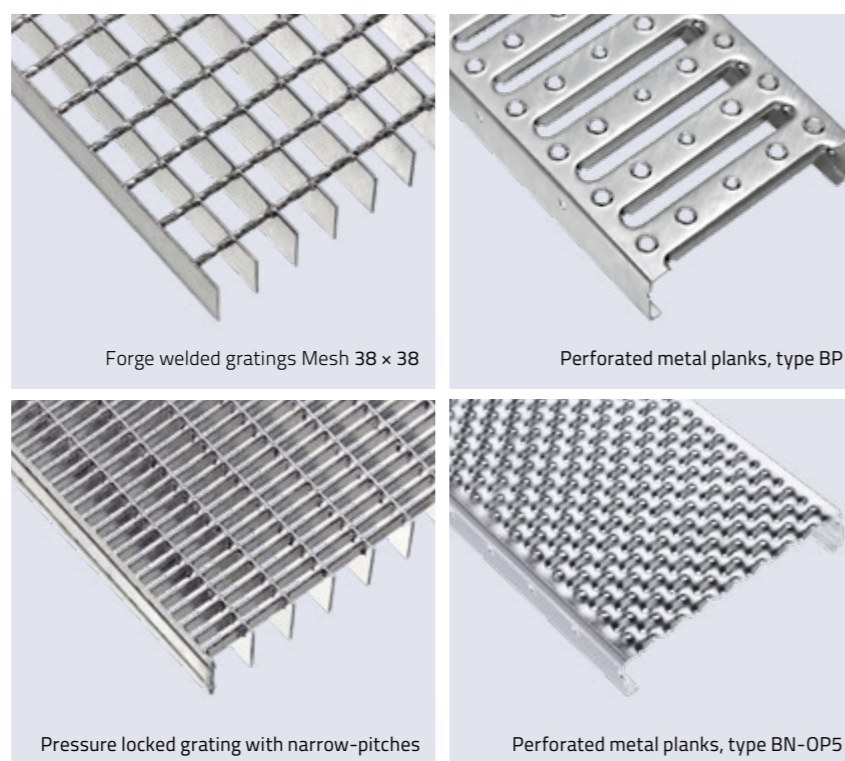

- + individual solutions for every static requirement
- + light and water permeability
- + high load capacity with low weight
- + slip-resistant versions
- + many different versions
- + fast assembly
- + various materials possible: steel, stainless steel, aluminum
- + various surface treatments

## POSSIBLE APPLICATIONS OF OUR PRODUCTS

### FOR THE RAILWAY SECTOR

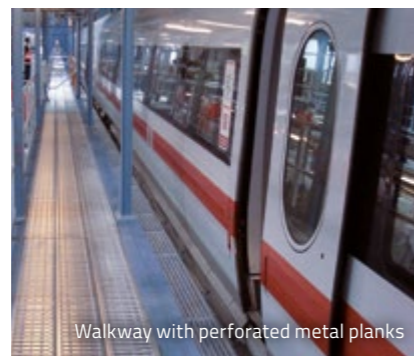
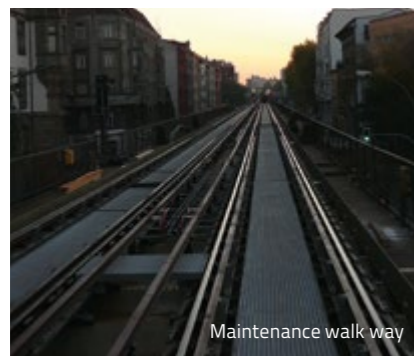

#### PLATFORMS, FLOORINGS AND WALKWAYS

Lichtgitter GRP platforms are made entirely of GRP according to recognized regulations. Even the substructure can consist of GRP profiles. The weather-resistant material makes GRP structures a long-term solution that requires almost no maintenance.

For our constructions, we only use GRP profiles with CE marking. Of course, gratings and perforated metal planks made of steel are also suitable for this application.



#### INTERNAL AND EXTERNAL CLEANING PLANTS

GRP gratings and GRP constructions are used for internal and external cleaning plants because of their high chemical resistance. Our products are especially resistant to aggressive cleaning agents.



#### TRACK CROSSINGS

GRP does not need to be earthed, is electrically non-conductive and thus the ideal material for track crossings. Track crossings consist of gratings and the complete substructure. Due to our wide stock range and short production times, we can react quickly to your individual application.

#### ESCAPE, TRACK AND RESCUE ROUTES

Due to the various production and surface options in both steel and GRP, escape and rescue routes can also be color-coded and thus receive a signal effect. A smaller mesh size and a slip-resistant surface also ensure a safe comfortable footing.



#### ACCESS PLATFORMS

Access platforms are used to enable the cleaning staff to easily access the trains outside the station. GRP platforms can be mounted and fastened easily and quickly on site, making them ideal for this purpose.

To get even more flexibility, mobile boarding aids have been developed. This small structure can easily be moved along a rail, allowing you to board the train at almost any location.

#### BRIDGE FLOORINGS

Whether as a service route on a railway bridge or as a pedestrian or bicycle path - with Lichtgitter industrial floor coverings, using bridges become safe and comfortable. Due to its dimensional stability, GRP has an extremely high durability and lower maintenance costs. Steel, on the other hand, fulfills almost every static requirement.



#### COVERINGS FOR COLLECTION TROUGHS

Concrete trough coverings made of gratings with corresponding substructure fulfill any given geometry of the collection troughs. We can offer gratings to carry pedestrians, cars or trucks. Other special floorings for special vehicles such as a reach stacker are also no problem for us

#### STAIRS & STAIRTREADS

Lichtgitter customized stair treads are manufactured in the same types and surface structures as the corresponding platforms. The optimum safety of the stair treads is achieved by attaching a leading edge. The steps can be made from steel, stainless steel, aluminum and GRP. Even completely finished systems can be offered in GRP.



### GRP RAILINGS / PLUGGABLE RAILINGS

We have also an answer for the ever-growing safety requirements e.g. in railway workshops, with our tailored railing systems - whether as fixed or removable railings.



GRP-Railing

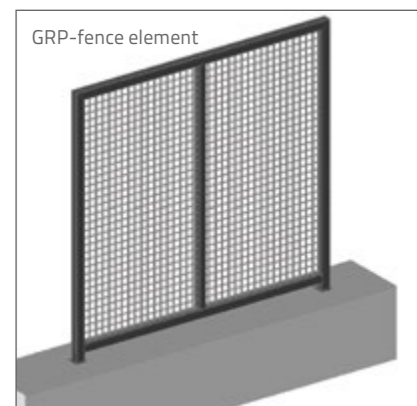
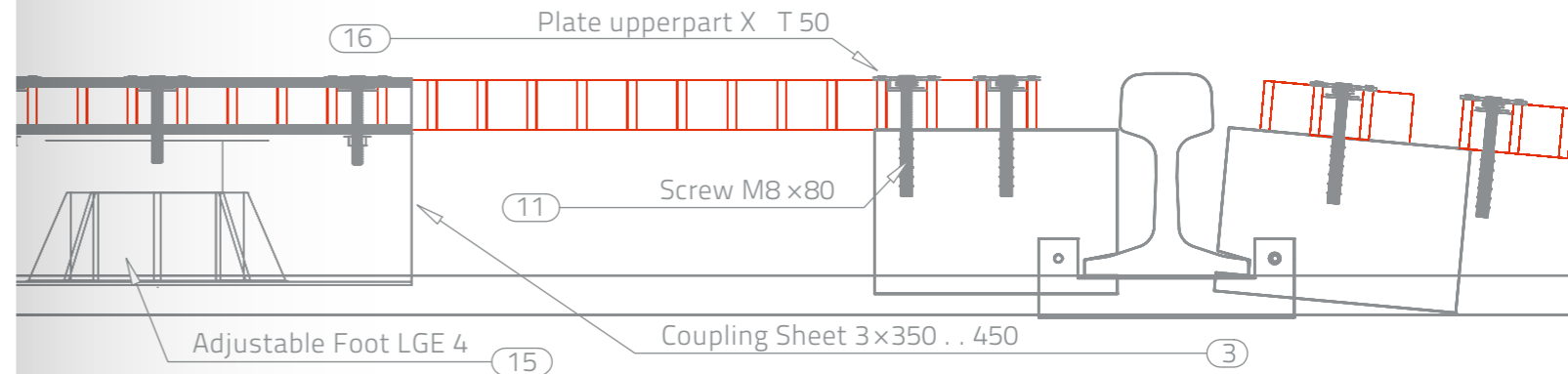

GRP-fence element

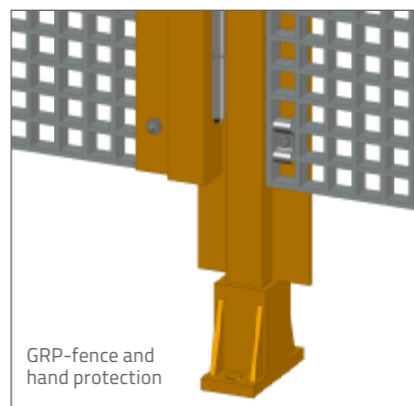

GRP-fence and hand protection

### FENCE SYSTEMS

Fence system made of GRP grating elements. We plan fence systems according to your individual requirements.

### OTHER PRODUCTS AND APPLICATION AREAS:

GRP safety plate & GRP safety step: Platform edge covers and safety step covers serve to repair wooden and concrete floors. The anti-slip class is R13.

Other applications can be heated crossings or entry aid or entry and exit aids.



GRP-Safety Plate



GRP-Safety Step

### LICHTGITTER-SERVICE

WITH THE HELP OF OUR SERVICES WE ENABLE YOU TO REACH YOUR TARGETS. WE OFFER A COMPETENT PRODUCT- AND BUILDING-LINKED ADVICE IN COMBINATION WITH HIGH TECHNICAL KNOW-HOW AND EXPERTISE.

For us it is a great pleasure to get inquiries which request individual demands and therefore lead to the developing of new application solutions. We offer support regarding the planning, preparation of layout drawings, design and technical documentation.

To ensure the high quality of our service the manufacturing of our products is monitored and assessed in accordance with all important standards and regulations. Lichtgitter GFK was one of the first companies to obtain the approval of the German Federal Railway Authority (EBA) as well as the manufacturer-specific product qualification (HPQ) for GRP gratings.

### ADVANTAGES

- + HPQ-certified and EBA-authorized
- + Technical advice on the calculation and selection of our different products
- + Preparation of auditable static verification
- + GRP-profiles with CE-marking
- + Preparation of installation plans
- + Production of 2D- and 3D drawings
- + Assembly for testing reasons at works
- + Appropriate packaging and consignment
- + Participation in national / international associations and committees to set rules and regulations



## REFERENCES

### FACADES



### CEILING COVERINGS

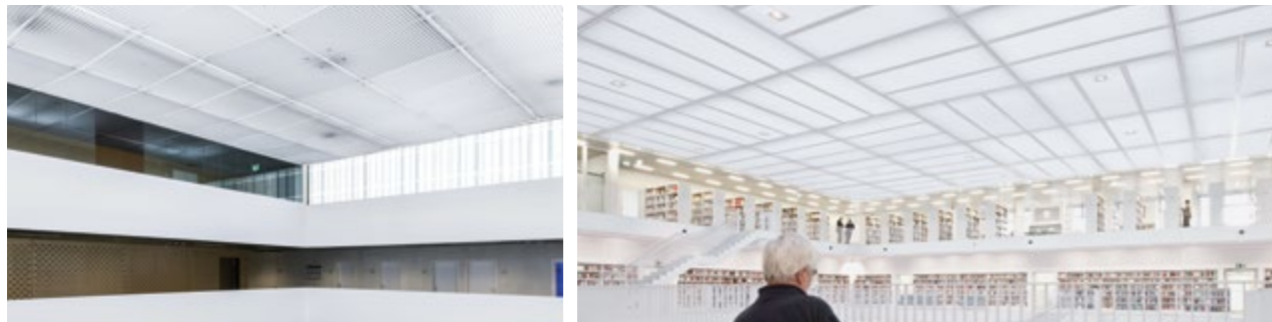

### SUN PROTECTION

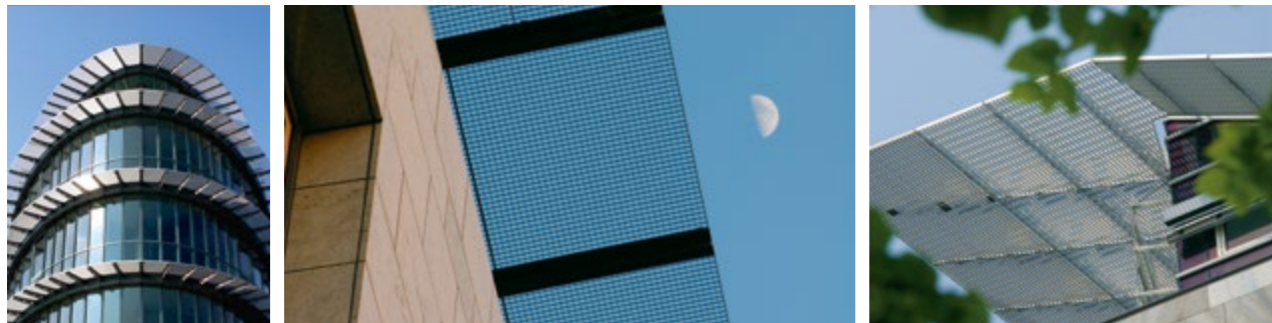

### STAIRS AND RAILINGS



### FLOOR COVERINGS/WALKWAYS

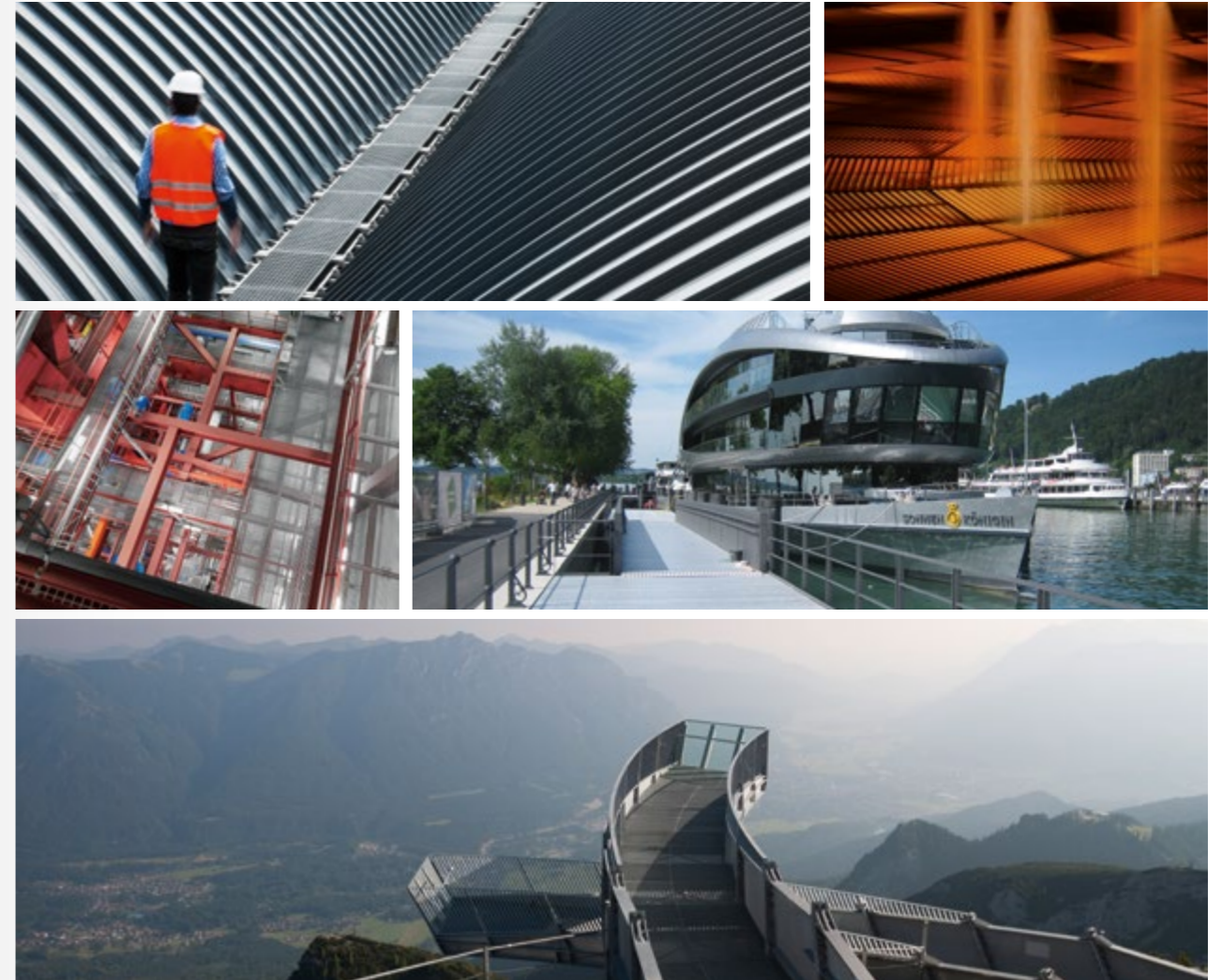

## LICHTGITTER – ABOUT US

### A BRIGHT OUTLOOK SINCE 1929

Lichtgitter was established in 1929 in order to carry out the specialized manufacturing of gratings. By the continuous monitoring of our performance and quality systems, together with innovation in manufacturing techniques, we have ensured Lichtgitter's place in the forefront of manufacturers of industrial floor coverings with subsidiaries all over the world. Besides the production

of pressure-locked gratings, forge-welded gratings and perforated metal planks, a various offer of GRP products are part of the production range. Our current product range also includes profiled chequer plates, spiral staircases, stairtreads and ladder rungs. Together with our steel slitting service centre and hot dip galvanizing plants we provide a complete

## EVERYTHING FROM ONE SOURCE:

forge-welded gratings, pressure-locked gratings,  
perforated metal planks, GRP-gratings, combi-deck,  
chequer plates, spiral staircases, stairtreads,  
ladder rungs, hot-dip galvanisation, steel service

### Lichtgitter GmbH

Siemensstraße 1  
D-48703 Stadtlohn  
Fon +49.2563.911-0  
Mail [info@lichtgitter.com](mailto:info@lichtgitter.com)

### Lichtgitter Blechprofilroste GmbH & Co. KG

Neckarwiesen 20  
D-72172 Sulz | Neckar  
Fon +49.7454.9582-0  
Mail [sulz@lichtgitter.com](mailto:sulz@lichtgitter.com)

### Lichtgitter Treppen GmbH & Co. KG

Schönowener Straße 6  
D-16306 Casekow-Blumberg  
Fon +49.33331.797-0  
Mail [blumberg@lichtgitter.com](mailto:blumberg@lichtgitter.com)

### Lichtgitter GFK GmbH & Co. KG

Siemensstraße 1  
D-48703 Stadtlohn  
Fon +49.2563.911-0  
Mail [info@lichtgitter.com](mailto:info@lichtgitter.com)